

SOPHIA - CRIB ASSEMBLY INSTRUCTIONS:

Scan the QR code to see additional Hanging Tips on our FAQ page:

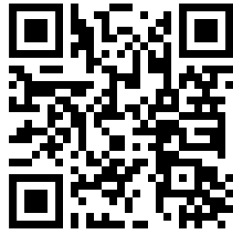



Tools Needed:

1 – Flat head screwdriver (Large)



Included:

Illustration	Part	Sophia Qty
	¼" NYLON WASHER	16
	¼" X 2" SS 18-8 SIDEWALK BOLT	16
ASSEMBLY INSTRUCTIONS	PRINTED	1
TOUCH-UP PAINT – Ordered Color 	.6 OZ BOTTLE	1

Swingbed Frame Components Included:

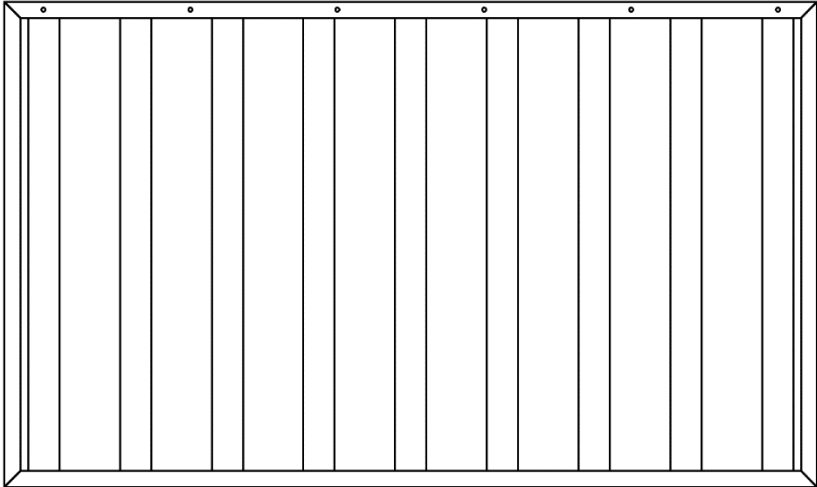
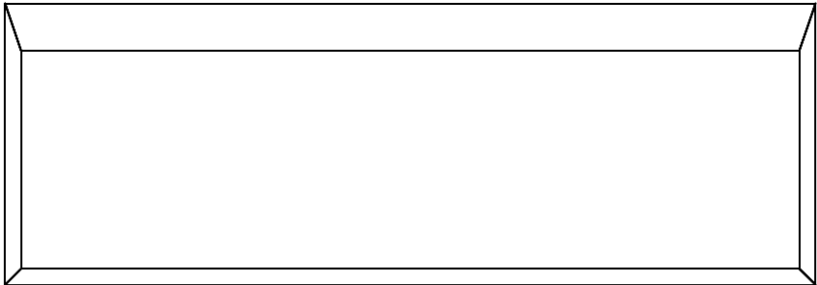
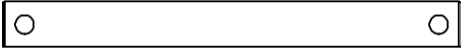
Illustration	Part	Sophia - Qty
	Seat	1
	Back	1
	Side Bar	2

ASSEMBLY NOTES:

- USE 1 NYLON WASHER WITH EACH BOLT
- DO NOT OVERTIGHTEN BOLTS
- DO NOT CRUSH NYLON WASHER

STEP 1:

LAY SEAT ON A FLAT SURFACE COVERED WITH THE SHIPPING BOX (OR SOMETHING SIMILAR) TO ELIMINATE DAMAGE DURING ASSEMBLY

STEP 2:

SET BACK ON SEAT BY ALIGNING CONNECTION HOLES

STEP 3:

USING 2" SIDEWALK BOLTS AND WASHERS (Qty 6), **LOOSELY** SECURE THE BACK PANEL TO THE SEAT ON THE BOTTOM ONLY. FINISH UP BY TIGHTEN ALL BOLTS TO FIRMLY SECURE THE 2 PIECES TOGETHER.

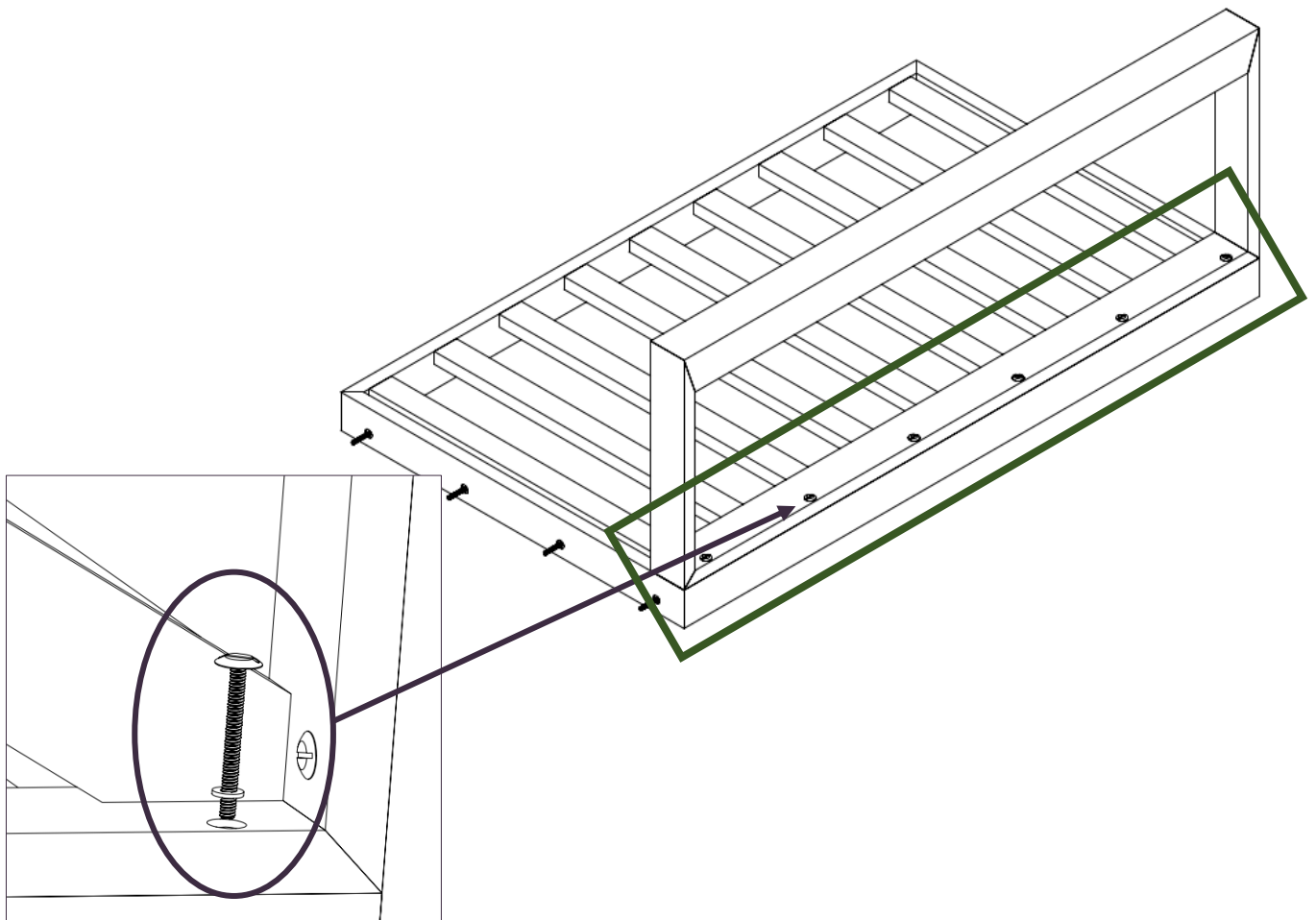

STEP 4:

LAY THE SWING ON IT'S BACK AND SECURE BOTH SIDE BARS TO THE SEAT FRAME USING 2" SIDEWALK BOLTS AND WASHERS (QTY 4 ON EACH SIDE). HANGING CHANNELS SHOULD BE RUNNING VERTICALLY.

NOTE: DO NOT OVERTIGHTEN BOLTS

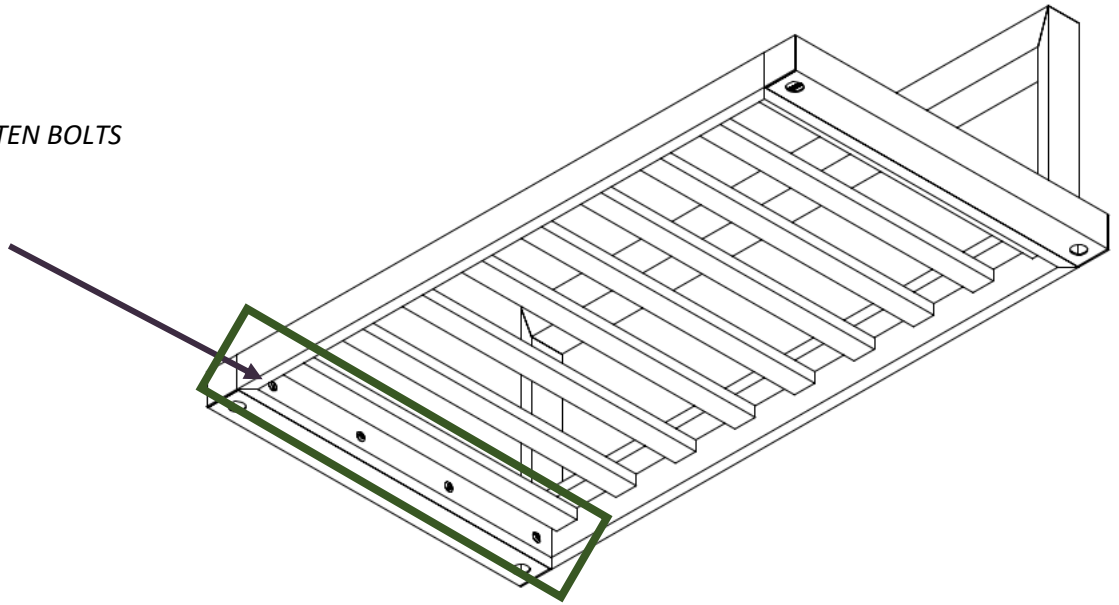

YOUR SWING IS NOW READY FOR HANGING HARDWARE AND INSTALLATION!

Let us hear from you!

support@havenandharmony.com

[727.597.4142](tel:727.597.4142)

