

# Swinging INTO SERENITY





SUSTAINABLE ALUMINUM | QUALITY CRAFTSMANSHIP | TRADITIONAL STYLE

# *Styles* & FEATURES



*Maggie*



*Sophia*



*Debbie*



*Connie*



*Shirley*

Sunbrella Cushion Bundle Upgrade & Rope & Chain Hanging Kits

Sustainable Aluminum & Lightweight Design

Easy Assembly & Twin & Crib Sizing\*

\*Custom sizes available\*

# *Powder Coat* FINISHES



Textured Black



Almond

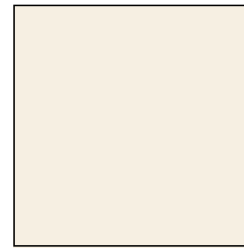

Oil Rubbed Bronze

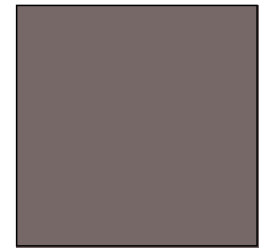

Military Blue



Slate Grey

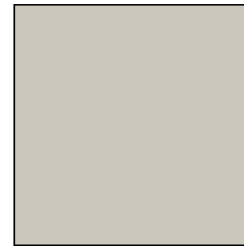

Textured white

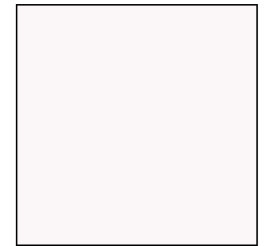

*Hangings*  
OPTIONS

*Rope Styles*



*Chain Styles*

Galvanized | Zinc | Stainless Steel



# *Optional* CUSHION BUNDLES

Elevate the swing bed experience with a **Sunbrella** cushion bundle available in twin and crib sizes, crafted from exclusive **Sunbrella** fabrics. Each bundle features a seat cushion with 5", 6", or 7" thick outdoor-rated foam, along with two back cushions and two bolsters for added comfort. Select from six Sunbrella Upholstery Fabrics to complement any outdoor decor.

Canvas Charcoal



Canvas Natural



Canvas White

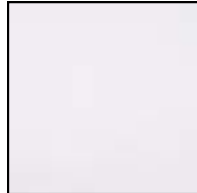

Blend Linen



Canvas Granite



Spectrum Indigo





H&H  
TRADE PROGRAM

Wholesale & Dealer Pricing

Powder Coat & Fabric Sampling

White Label Options & Ship Direct To Consumer

# The Future of SWING BED COMFORT



## A Sustainable Swing Bed Story

Embark on a journey into the realms of opulence & eco-conscious living with our revolutionary aluminum swing bed. A standout amidst the conventional wooden counterparts, this innovative creation represents the pinnacle of expert craftsmanship & environmental mindfulness. We are ushering in a new era of swing beds, seamlessly blending luxury with sustainability. Our goal is to redefine both outdoor & indoor living experiences, ensuring they endure the passage of time with grace & style.

## Family Values

Haven & Harmony was founded by the Schechner Family. They have a long-standing tradition of craftsmanship, with two generations of skilled artisans perfecting the quality techniques. Each swing bed is carefully handcrafted, ensuring attention to detail & superior quality. The smooth lines, detailed designs, & impeccable finishes reflect the passion & pride invested in each Swing Bed that is created.

*The* MAGGIE



# MAGGIE SWING BED – A HOMAGE TO MOUNTAIN TRANQUILITY

## Handcrafted From Sustainable Aluminum

Meet the Maggie Swing Bed, a tribute to the serene life of Our Mountain Momma, who found solace in the Appalachian Mountains after a lifetime in bustling Florida. Designed with a country farmhouse style and charming crossed slat arms, this swing bed encapsulates the essence of country living, inviting you to unwind, breathe in the fresh mountain air, and savor the tranquility of nature.

### Product Details

- Made in the U.S.A, in Clearwater, FL ensuring superior quality and durability.
- **Simple Assembly:** Easy-to-follow instructions
- **Sturdy Aluminum Frame:** Welded from high-quality aluminum, the frame offers stability and longevity, even in outdoor environments.
- **Premium Powder Coated Finish:** Available in six elegant color options, the powder coated finish enhances both aesthetics and durability.
- **Sized to fit:** Currently available in two sizes; twin and crib
- **Cushion Bundles:** Elevate your space with our Swing Bed cushion bundle exclusively offered in Sunbrella fabrics.
- **Weight Capacity:** Designed to accommodate 500-900 lbs.
- **Frame Weight:** 78 lbs (Twin)
- **Cushion Bundle Weight:** 36 lbs (Twin)
- **Optional Hanging Kits:** Tailor your swing bed look with our rope or chain hanging kits.
- **Optional install hardware:** Swing Mate and Swing Mate deluxe
- **Optional Seasonal Cover:** Available in Sunbrella Shade fabric

Textured Black



Almond



Oil Rubbed Bronze



Military Blue



Slate Grey



Textured white



# MAGGIE SWING BED

Twin Size

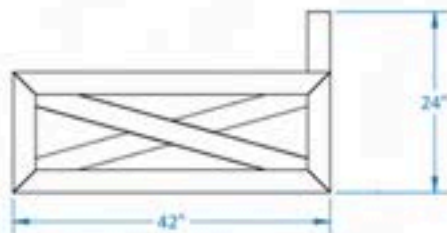
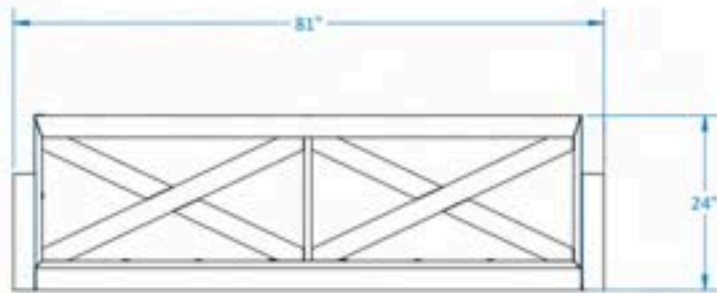
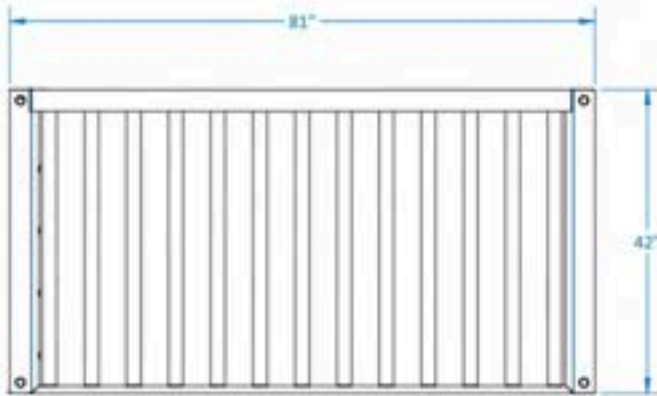

Crib Size

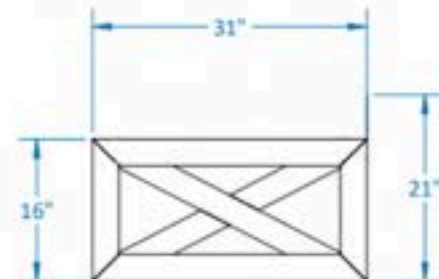
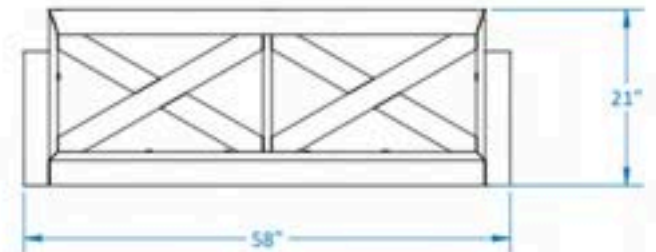
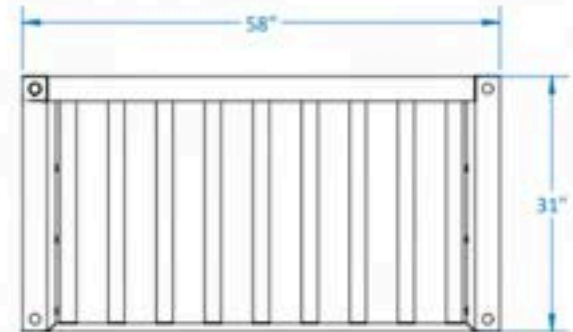

*The* SOPHIA



# SOPHIA SWING BED – WHERE MODERN ELEGANCE MEETS YOUTHFUL SPIRIT

## Handcrafted From Sustainable Aluminum

Meet The Sophia Swing Bed, the embodiment of modern style and youthful exuberance. Named after the youngest member of the Haven and Harmony Swing Beds legacy, this sleek swing bed design captures the essence of contemporary minimalism. Sophia's swing bed is not just a piece of furniture; it's an Instagram-worthy statement, reflecting her trendy and cool personality.

### Product Details

- Made in the U.S.A, in Clearwater, FL ensuring superior quality and durability.
- **Simple Assembly:** Easy-to-follow instructions
- **Sturdy Aluminum Frame:** Welded from high-quality aluminum, the frame offers stability and longevity, even in outdoor environments.
- **Premium Powder Coated Finish:** Available in six elegant color options, the powder coated finish enhances both aesthetics and durability.
- **Sized to fit:** Currently available in two sizes; twin and crib
- **Cushion Bundles:** Elevate your space with our Swing Bed cushion bundle exclusively offered in Sunbrella fabrics.
- **Weight Capacity:** Designed to accommodate 500-900 lbs.
- **Frame Weight:** 52 lbs (Twin)
- **Cushion Bundle Weight:** 36 lbs (Twin)
- **Optional Hanging Kits:** Tailor your swing bed look with our rope or chain hanging kits.
- **Optional install hardware:** Swing Mate and Swing Mate deluxe
- **Optional Seasonal Cover:** Available in Sunbrella Shade fabric

Textured Black



Almond



Oil Rubbed Bronze



Military Blue



Slate Grey



Textured white



# SOPHIA SWING BED

Twin Size

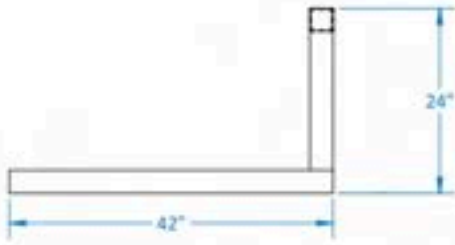
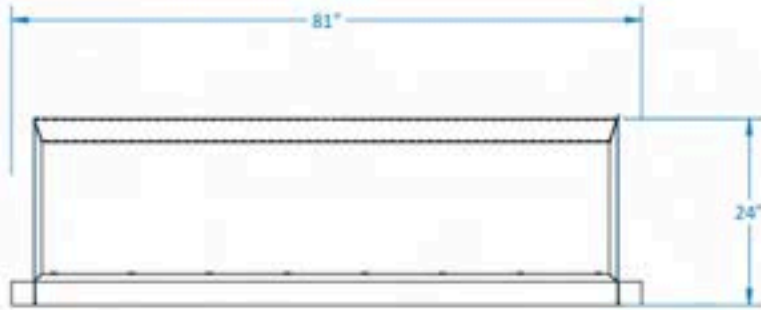
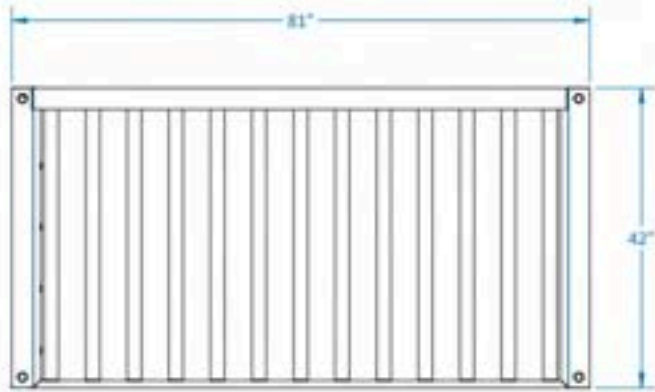

Crib Size

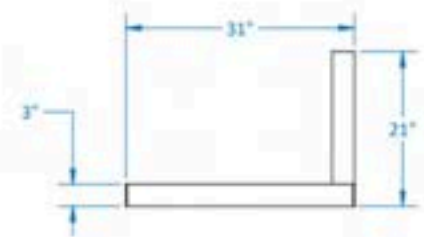
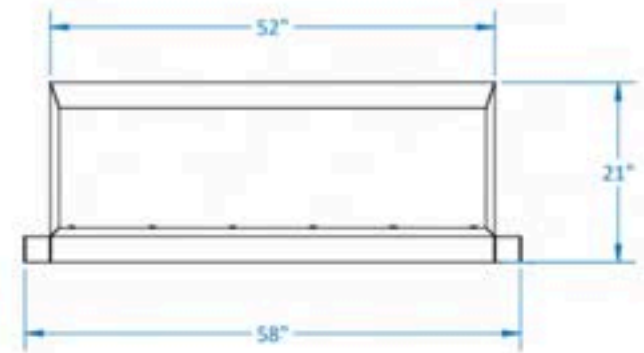
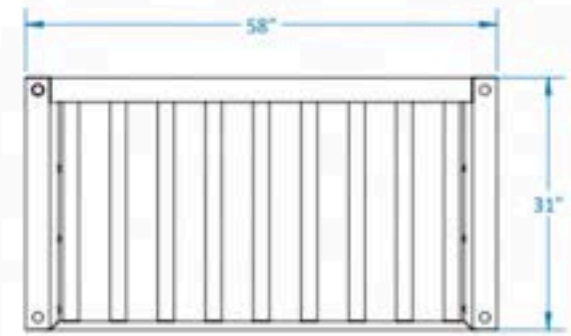

*The* SHIRLEY



# SHIRLEY SWING BED – DISCOVER SERENITY IN STYLE

## Handcrafted From Sustainable Aluminum

Meet The Shirley Swing Bed, Inspired by the elegance and grace of our Brooklyn mom. This swing bed is a tribute to her impeccable taste, great sense of humor, and enduring love for family. The Shirley Swing Bed is not just a piece of furniture; it's an invitation to escape, unwind, and revel in the simple joys of life. Whether you're enjoying a peaceful nap or losing yourself in the pages of a book, let the Shirley Swing Bed be your sanctuary of tranquility and style.

### Product Details

- Made in the U.S.A, in Clearwater, FL ensuring superior quality and durability.
- **Simple Assembly:** Easy-to-follow instructions
- **Sturdy Aluminum Frame:** Welded from high-quality aluminum, the frame offers stability and longevity, even in outdoor environments.
- **Premium Powder Coated Finish:** Available in six elegant color options, the powder coated finish enhances both aesthetics and durability.
- **Sized to fit:** Currently available in two sizes; twin and crib
- **Cushion Bundles:** Elevate your spaces with our Swing Bed cushion bundle exclusively offered in Sunbrella fabrics.
- **Weight Capacity:** Designed to accommodate 500-900 lbs.
- **Frame Weight:** 82 lbs (Twin)
- **Cushion Bundle Weight:** 36 lbs (Twin)
- **Optional Hanging Kits:** Tailor your swing bed look with our rope or chain hanging kits.
- **Optional install hardware:** Swing Mate and Swing Mate deluxe
- **Optional Seasonal Cover:** Available in Sunbrella Shade fabric

Textured Black



Almond



Oil Rubbed Bronze



Military Blue



Slate Grey



Textured white



# SHIRLEY SWING BED

Twin Size

Crib Size

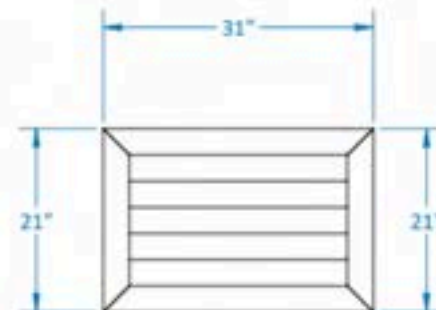
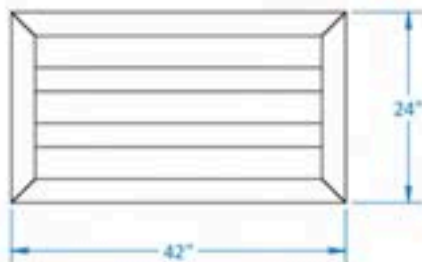
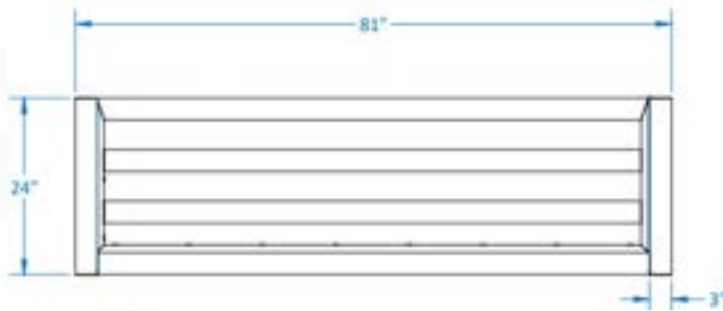
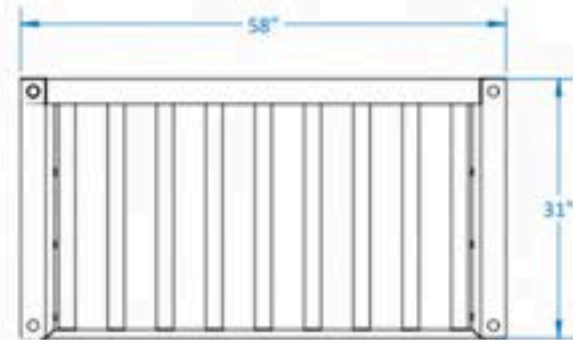
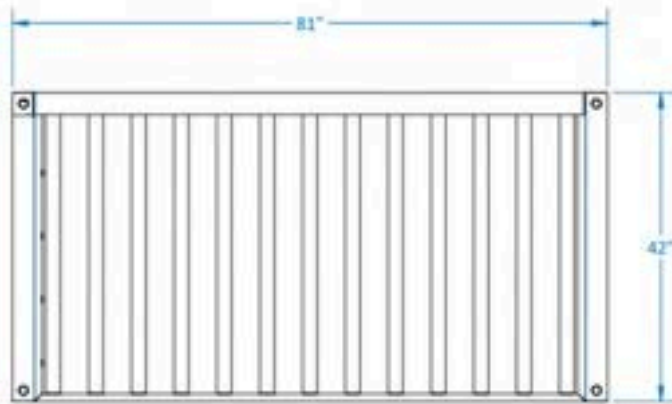

*The* CONNIE



# CONNIE SWING BED – TIMELESS MODERN MIX

## Handcrafted From Sustainable Aluminum

Meet The Connie Swing Bed, paying homage to Cornelia Fox. Cornelia is the families beloved Maternal Great Grandmother, affectionately known as "Connie." This swing bed is a tribute to her love for Hollywood glamour, movies, and the joy she found in every moment of life. Connie's spirit, a perfect blend of tradition and modernity, is mirrored in the design of this swing bed.

### Product Details

- Made in the U.S.A, in Clearwater, FL ensuring superior quality and durability.
- **Simple Assembly:** Easy-to-follow instructions
- **Sturdy Aluminum Frame:** Welded from high-quality aluminum, the frame offers stability and longevity, even in outdoor environments.
- **Premium Powder Coated Finish:** Available in six elegant color options, the powder coated finish enhances both aesthetics and durability.
- **Sized to fit:** Currently available in two sizes; twin and crib
- **Cushion Bundles:** Elevate your spaces with our Swing Bed cushion bundle exclusively offered in Sunbrella fabrics.
- **Weight Capacity:** Designed to accommodate 500-900 lbs.
- **Frame Weight:** 82 lbs (Twin)
- **Cushion Bundle Weight:** 36 lbs (Twin)
- **Optional Hanging Kits:** Tailor your swing bed look with our rope or chain hanging kits.
- **Optional install hardware:** Swing Mate and Swing Mate deluxe
- **Optional Seasonal Cover:** Available in Sunbrella Shade fabric

Textured Black



Almond



Oil Rubbed Bronze



Military Blue



Slate Grey



Textured white



# CONNIE SWING BED

Twin Size

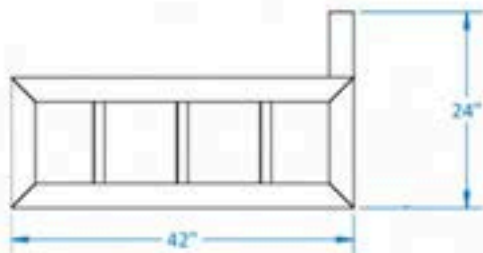
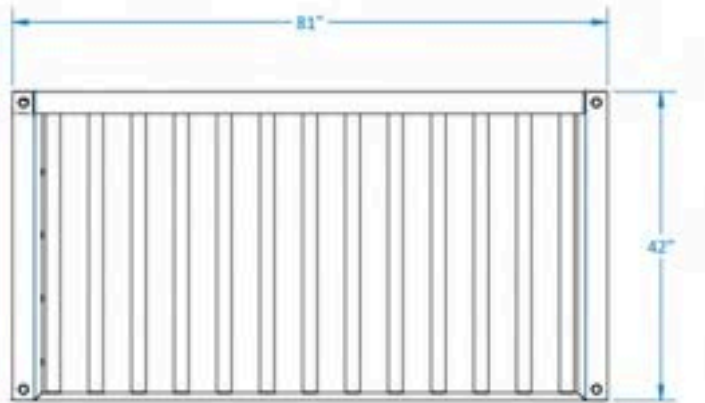

Crib Size

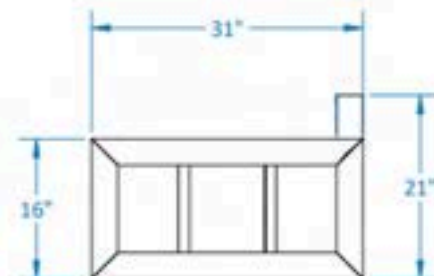
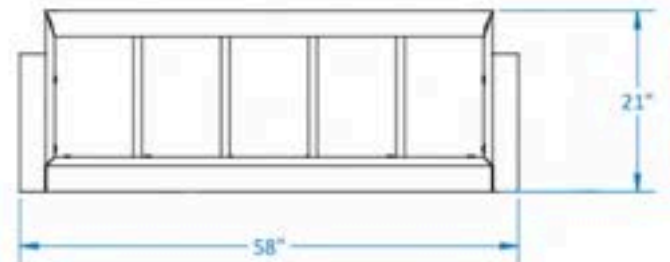
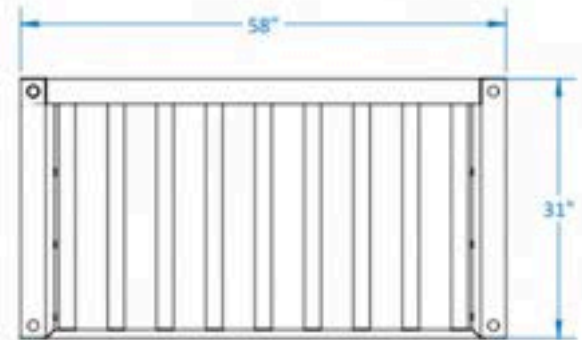

*The* DEBBIE



# DEBBIE SWING BED – WHERE BEACH DREAMS COME TRUE

## Handcrafted From Sustainable Aluminum

Meet The Debbie Swing Bed, named in honor of Debbie the quintessential mermaid of St. Pete. Her love for the ocean and seashells transformed her home into a haven of imagination and beachy bliss. Born a Brooklyn girl, her heart always belonged to the sea, and in the 1980s, she fulfilled her dream of coastal living in sunny Florida. Let the Debbie Swing Bed be your sanctuary of beachy bliss and imagination, where every day feels like a day at the beach.

### Product Details

- Made in the U.S.A, in Clearwater, FL ensuring superior quality and durability.
- **Simple Assembly:** Easy-to-follow instructions
- **Sturdy Aluminum Frame:** Welded from high-quality aluminum, the frame offers stability and longevity, even in outdoor environments.
- **Premium Powder Coated Finish:** Available in six elegant color options, the powder coated finish enhances both aesthetics and durability.
- **Sized to fit:** Currently available in two sizes; twin and crib
- **Cushion Bundles:** Elevate your spaces with our Swing Bed cushion bundle exclusively offered in Sunbrella fabrics.
- **Weight Capacity:** Designed to accommodate 500-900 lbs.
- **Frame Weight:** 88 lbs (Twin)
- **Cushion Bundle Weight:** 36 lbs (Twin)
- **Optional Hanging Kits:** Tailor your swing bed look with our rope or chain hanging kits.
- **Optional install hardware:** Swing Mate and Swing Mate deluxe
- **Optional Seasonal Cover:** Available in Sunbrella Shade fabric

Textured Black



Almond



Oil Rubbed Bronze



Military Blue



Slate Grey



Textured white



# DEBBIE SWING BED

Twin Size

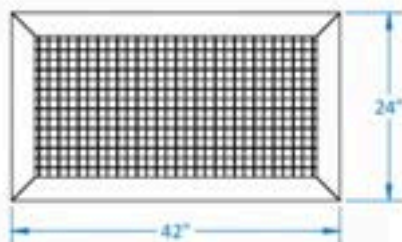
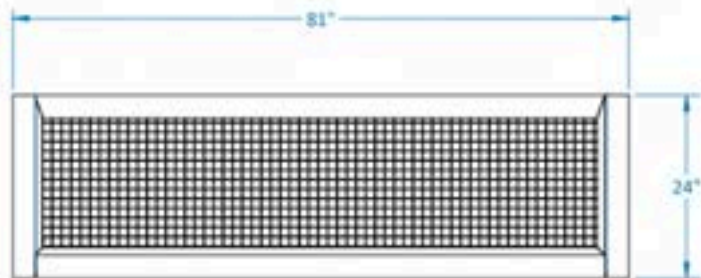
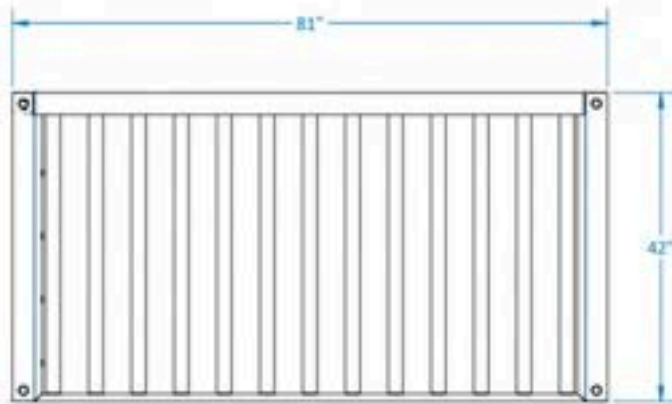

Crib Size

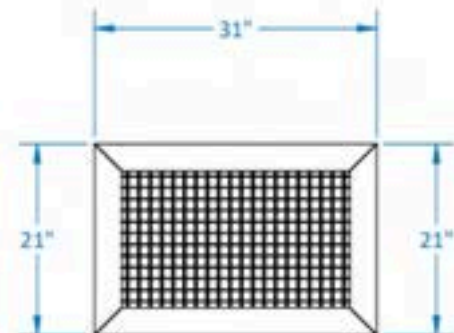
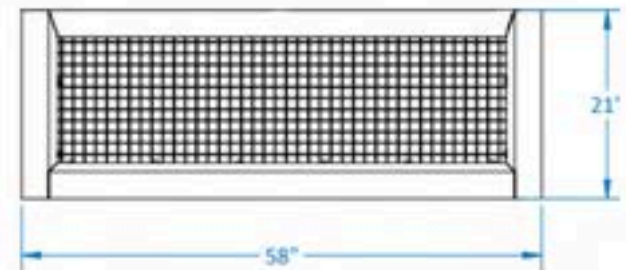
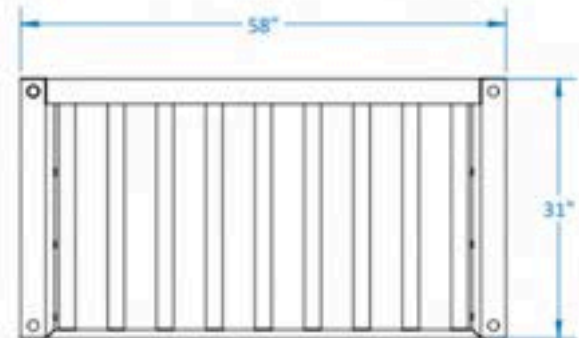



*Haven & Harmony*  
SWING BED COMPANY

10820 US 19 N Clearwater, FL. 33764 727.597.4142